

16.216SJ

Galvaniseret snaplås. 67 x 48 mm.
Galvanized fastener. 67 x 48 mm.

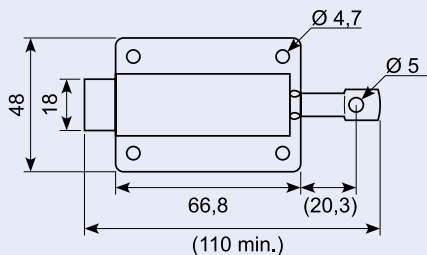

16.209

Galvaniseret skydelås. Rustfri bøjle med nylontunge. 40 x 70 mm plade med side pind.

Galvanized sliding latch. 40 x 70 mm plate with side pin.

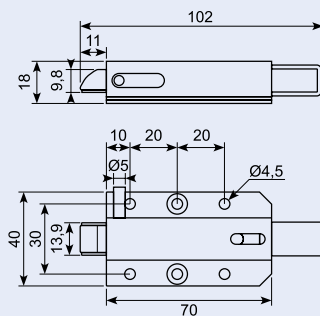

16.207

Galvaniseret skydelås. rustfri bøjle med nylontunge. 40x70 mm plade.

Galvanized sliding latch. 40 x 70 mm plate.

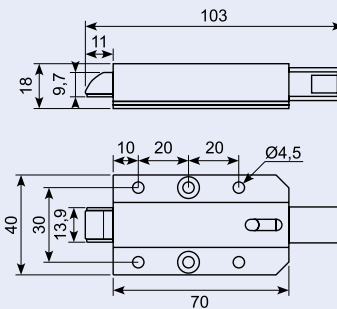

16.213J

Galvaniseret snaplås. Støbt massiv næse.

Galvanized latch. Cast massive nose.

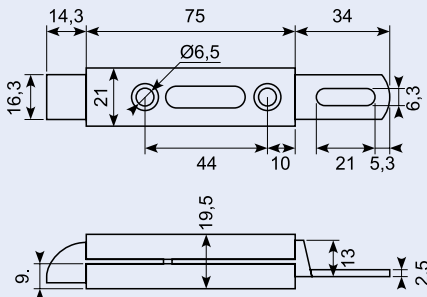

16.203J

Galvaniseret snaplås med krog.

Galvanized latch with hook.

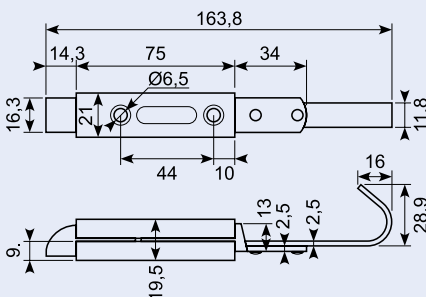
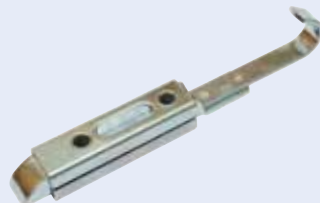

16.203SS

Snarlås Rustfri med krog. Tractive force 21N. Lidt blødere fjeder end 16.203J.

Stainless latch with hook. Tractive force 21N. Spring a little softer than 16.203J.

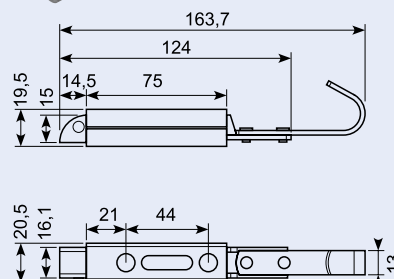

16.204

Galvaniseret skydelås.

Galvanized latch.

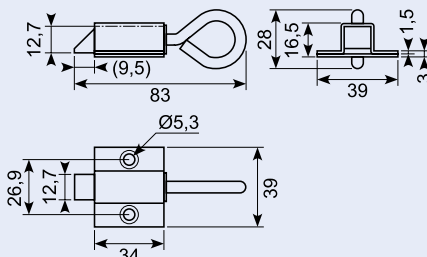

16.214

Snarlås, sort kunststof.

Moulded slam latch, black synthetic material.

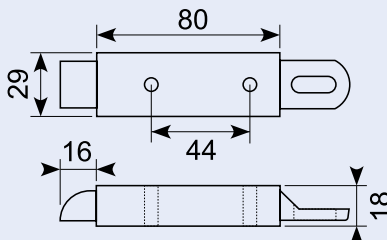
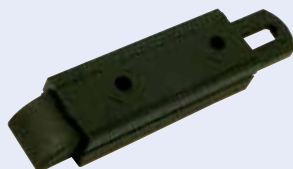

16.216S

Snarlås til 16.216MR/MRJX. "Nose down". Quick fit pull.

End latch for 16.216MR/MRJX. "Nose-down". Quick-fit pull.

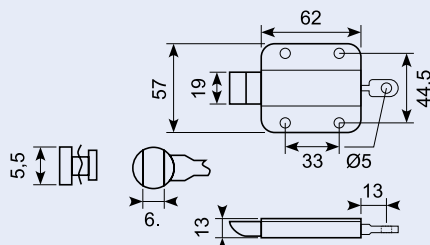
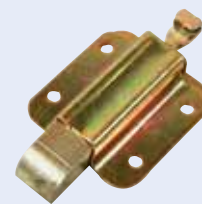

16.205X

Snaplås i galvaniseret stål med omvendt gæk.

Top-knob latch, nose-up mild steel.

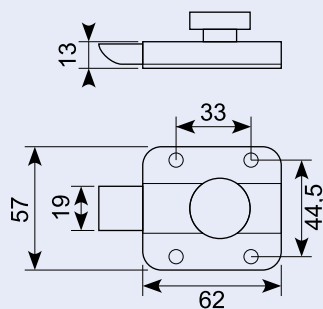
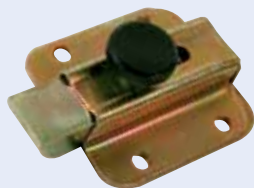

16.205

Snaplås, galvaniseret stål med knop.

Top-knob latch, nose-down. Mild steel.

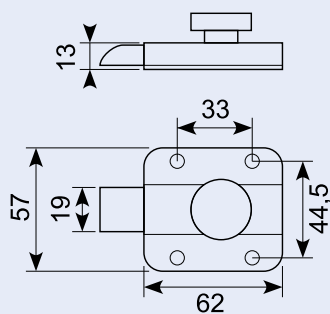
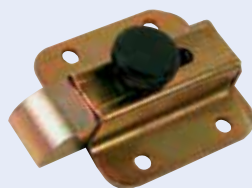

16.205R

Snaplås, rustfrit stål med knop.

Top-knob latch, nose-down SS.

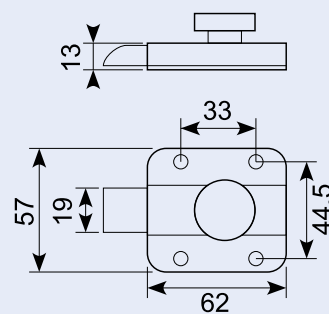
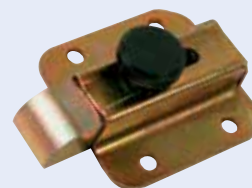

16.179

Hagelås - venstre. Galvaniseret stål, til 8 mm stift

Flush fitting lock - LH. Zink-plated, for 8 mm pin. Flush fitting lock left.

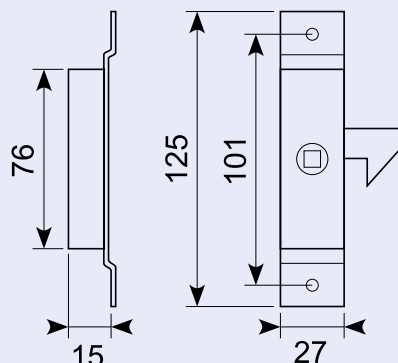

16.180

Hagelås - højre. Galvaniseret stål, til 8 mm stift.

Flush fitting lock - RH. Zink-plated, for 8 mm pin. Flush fitting lock right.

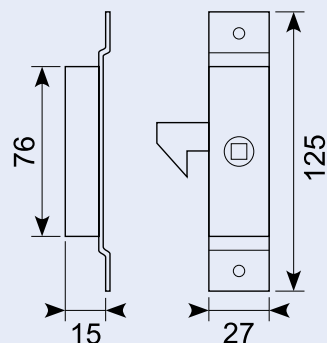

16.101J

Dørlås 7mm FK. 4 - 8 micron. Se også 16.101JSS.

Door lock. 7 mm FK. 4 - 8 micron. Also see 16.101JSS.

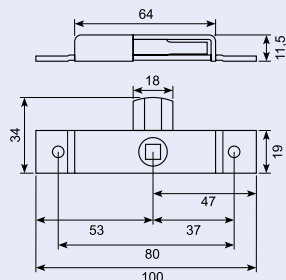
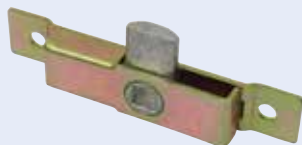

16.101JSS

Dørlås. 7 mm FK. Rustfri SS304 + zink cam.

Door lock. 7 mm FK. Stainless SS304 + zinc cam.

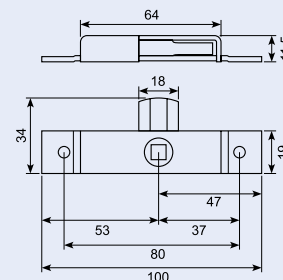

16.100R

Tungelås uden sikring. Rustfri stål, til 8 mm stift.

Stainless steel, for 8 mm T-key

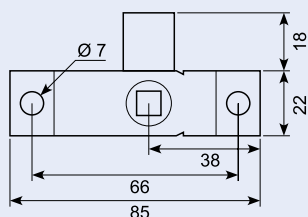

16.100X

Tungelås uden sikring. Galvaniseret stål med ståltunge, til 8 mm stift.

With steel bolt, for 8 mm T-key.

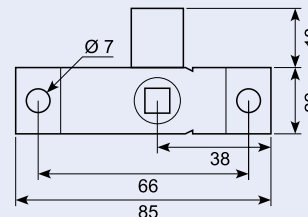

16.102

Tungelås uden sikring. Galvaniseret jern til 8 mm stift.

Latch lock without safety device. Zinc-plated steel, for 8 mm pin.

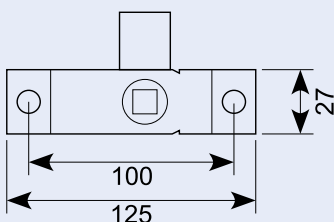

16.103

Tungelås uden sikring - venstre. Zink-plated stål, til 8 mm stift.

Handed budget latch - LH. Zinc-plated, for 8 mm T-key.

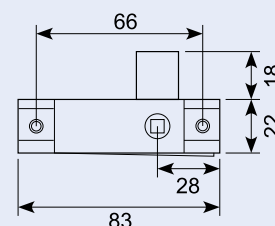
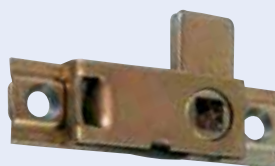

16.104

Tungelås uden sikring - højre. Galvaniseret stål, til 8 mm. stift.

Handed budget latch - RH. Zinc-plated, for 8 mm T-key.

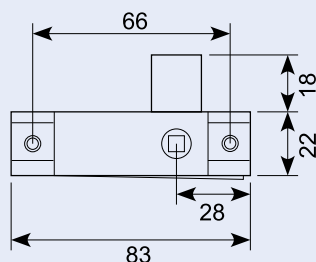

50.064110

Dørlås, galvaniseret. 27 x 125 mm. Hulafstand: 102 mm

Door lock.

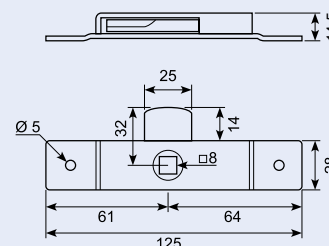
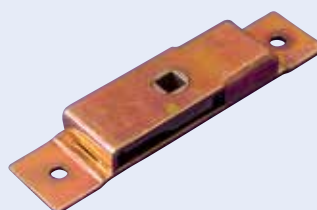

50.064120

Dørlås, galvaniseret og aluminium tunge.

22 x 115 mm. Hulafstand: 94 mm

Door lock.

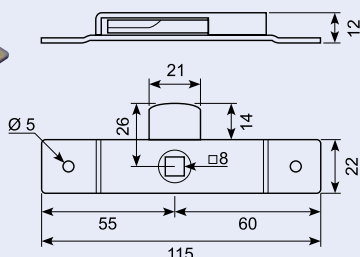
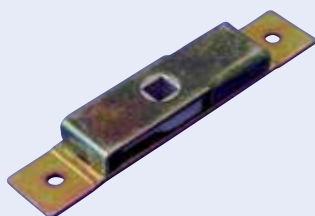

50.064130

Dørlås, galvaniseret. 19 x 105 mm. Hulafstand: 86 mm

Door lock.

