

Kantlister

Edge trims

Hjørner og kanter er ofte udsat for ekstra slitage og stød. Derfor kan det være en stor fordel at anvende kantlister produceret i gummi.

Kantlister bruges i dørkanter, trucks, rundt om vinduer, til stole, motordele, kabinetter mm.

Vi har mange forskellige lister på lager, som hver især er specificeret i forhold til type, kvalitet, med og uden ballon osv. Hvis vi ikke har produktet på lager, kan vi også levere specialprofiler på bestilling. Vi er derfor stolte af at sige, at vi kan løse næsten alle typer opgaver.

Med det store udvalg følger naturligvis en stor viden, som vi gerne deler ud af, skulle du have brug for det. Vi kan hjælpe dig omkring dit valg og kan besvare spørgsmål om stort set alt vedrørende vores kantlister.

Corners and edges are often exposed to additional wear and tear and bumps. Therefore, it can be a great advantage to use edge trims made of rubber. Edge trims are used in door edges, trucks, around windows, for chairs, engine parts, cabinets, etc.

We have many different edgetrims in stock, each one with specific characteristics in terms of type, quality, with and without balloon, etc. If we do not have the product in stock, we can supply special profiles on order. Therefore, we are also proud to say that we can solve all kinds of tasks.

Having large range of products also requires us to be knowledgeable, and if needed we are happy to share this knowledge with you. We can help you with your choice and answer any questions you might have concerning edge trims in our range.

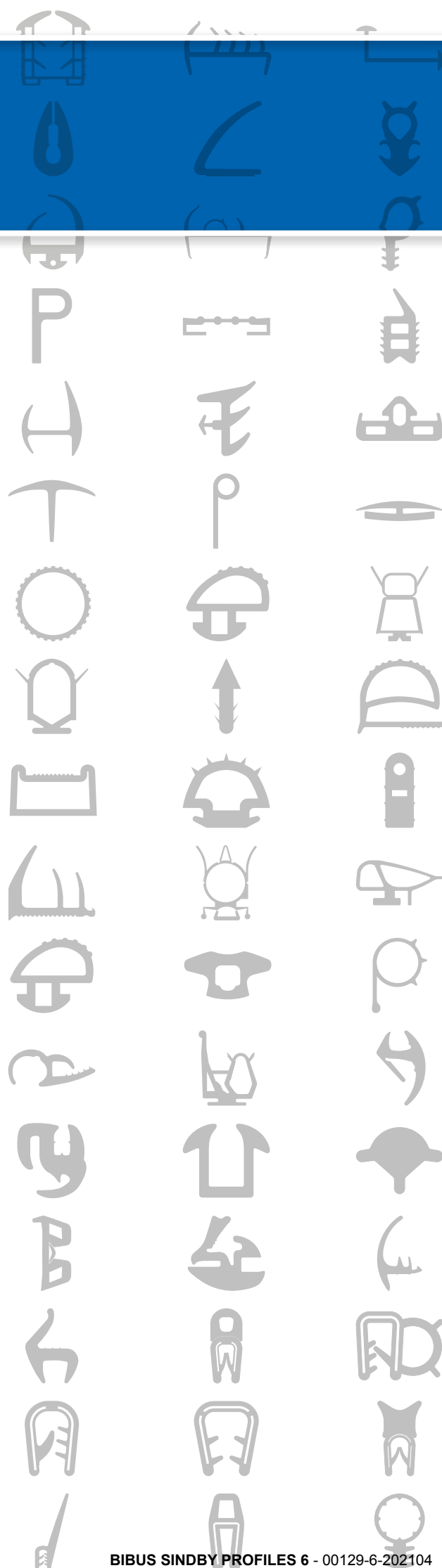

Kantlister / Edge trims

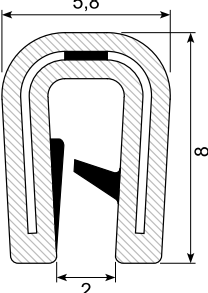
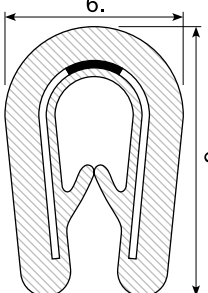
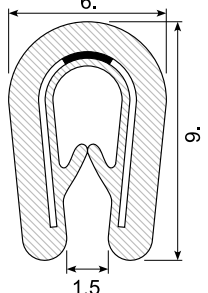
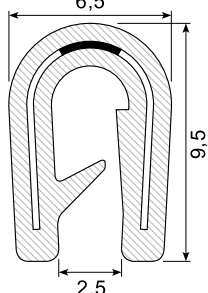
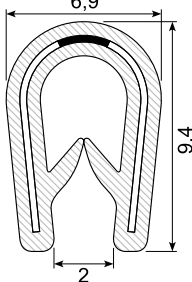
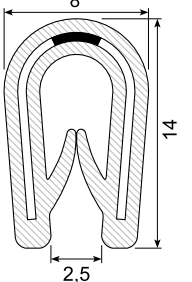
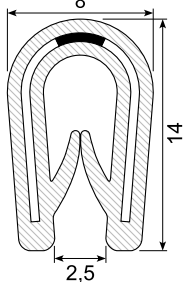
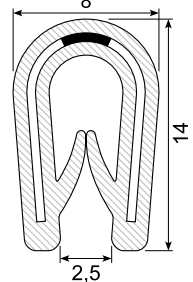
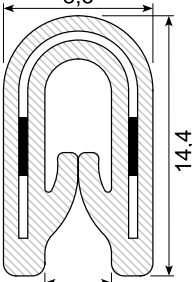
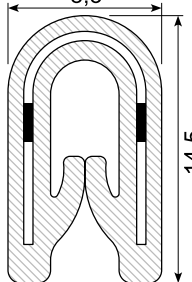
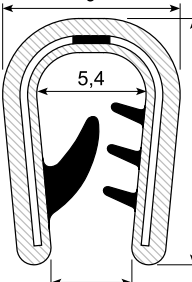
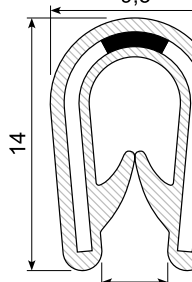
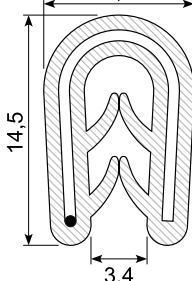
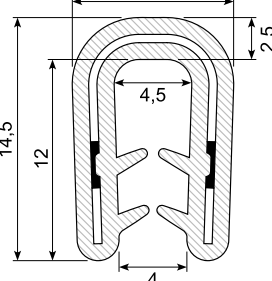
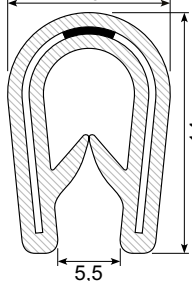
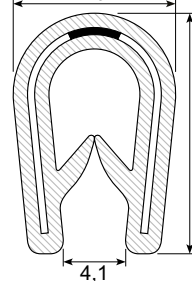
<p>33.306</p>  <p>Edge trim: PVC, black + bi Grip range: 1 - 2 mm Hardness: SH 75 / 65 Insert: 15 x 0,3 mm steel</p>	<p>33.409F</p>  <p>Edge trim: EPDM Grip range: 1 - 2 mm Hardness: SH 60 Insert: Steel Flame retardent EN 45545</p>	<p>33.409 / 33.401G</p>  <p>Edge trim: PVC, black / grey Grip range: 1 - 2 mm Hardness: SH 78 Insert: 16 x 0,3 mm steel 33.401G: Grey</p>	<p>33.307A</p>  <p>Edge trim: PVC, black Grip range: 1 - 2 mm Hardness: SH 75 Insert: 17,5 x 0,3 mm steel On cardboard coil</p>
<p>33.410X / 33.410XG</p>  <p>Edge trim: PVC, black / grey Grip range: 1 - 2 mm Hardness: SH 75 Insert: 17,5 x 0,3 mm steel 33.410XG: Grey</p>	<p>33.310X</p>  <p>Edge trim: PVC, black Grip range: 1 - 3 mm Hardness: SH 75 Insert: 26 x 0,47 mm steel</p>	<p>33.310SS</p>  <p>Edge trim: PVC, black Grip range: 1 - 2,5 mm Hardness: SH 70 - 75 Insert: 26 x 0,5 mm Stainless Steel SS 304</p>	<p>33.310SS-316</p>  <p>Edge trim: PVC, black Grip range: 1 - 2,5 mm Hardness: SH 70 - 75 Insert: 26 x 0,5 mm Stainless Steel SS 316 Acid-proof</p>
<p>33.422</p>  <p>Edge trim: TPE, flexible Grip range: 1 - 2,5 mm Hardness: SH 82 Insert: 25 x 0,48 mm steel</p>	<p>33.309XM</p>  <p>Edge trim: PVC, mokka brown Grip range: 1 - 2,5 mm Hardness: SH 78 Insert: Steel Special offer</p>	<p>33.418SS</p>  <p>Edge trim: PVC, black + bi Grip range: 1,5 - 3 mm Hardness: SH 78 / 78 Insert: 26 x 0,5 mm Stainless 304 steel</p>	<p>33.308A</p>  <p>Edge trim: PVC, black Grip range: 1 - 4 mm Hardness: SH 75 Insert: 26 x 0,47 mm steel On cardboard coil</p>
<p>33.432</p>  <p>Edge trim: EPDM Grip range: 1 - 3 mm Hardness: SH 65 Insert: 27 mm wire</p>	<p>33.438</p>  <p>Edge trim: EPDM Grip range: 1,5 - 3,5 mm Hardness: SH 65 Insert: 29 x 0,5 mm steel</p>	<p>33.420X</p>  <p>Edge trim: PVC, black Grip range: 1 - 4 mm Hardness: SH 75 Insert: 27 x 0,47 mm steel</p>	<p>33.420H</p>  <p>Edge trim: PVC, white Grip range: 1 - 4 mm</p>

Kantlister / Edge trims

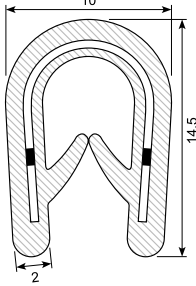
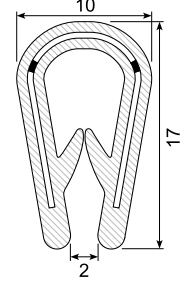
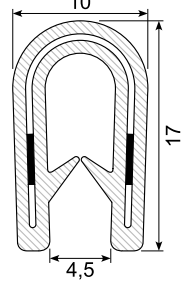
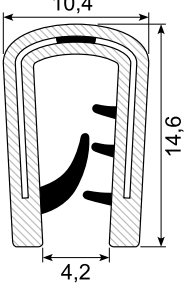
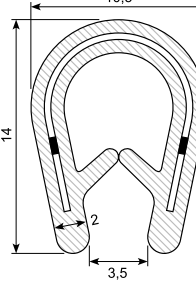
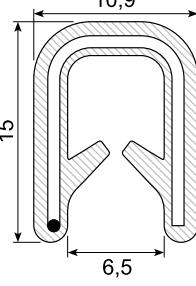
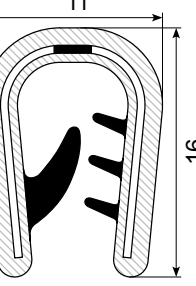
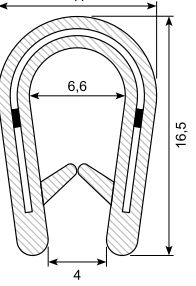
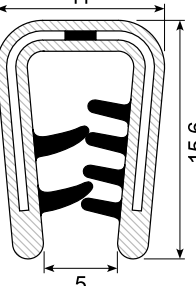
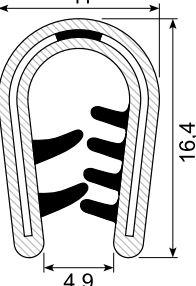
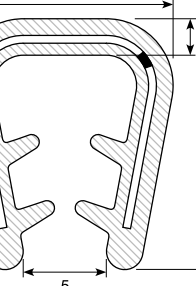
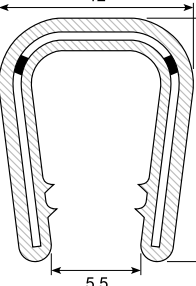
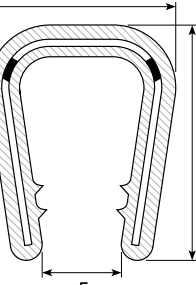
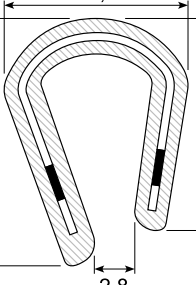
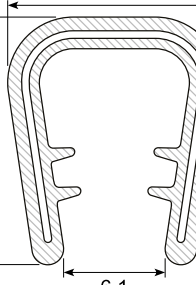
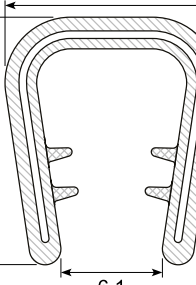
<p>33.420F</p>  <p>Edge trim: EPDM Grip range: 1,0 - 3,0 mm Hardness: SH 65 Insert: 26 x 0,5 mm steel Flame retardant ref. NNF 16101 (Certificate valid only 2016)</p>	<p>33.419</p>  <p>Edge trim: PVC, black Grip range: 1,0 - 4,0 mm Hardness: SH 78 Insert: 31 x 0,5 mm steel</p>	<p>33.411</p>  <p>Edge trim: PVC, grey Grip range: 2,5 - 4,0 mm Hardness: SH 78 Insert: 29 x 0,48 mm steel</p>	<p>33.418X</p>  <p>Edge trim: PVC, black + bi Grip range: 2,0 - 5,0 mm Hardness: SH 75 / 75 Insert: 26 x 0,47 mm steel White lips</p>
<p>33.420FX</p>  <p>Edge trim: EPDM Grip range: 1,0 - 3,0 mm Hardness: SH 60 Insert: 26 x 0,5 mm steel Flame retardant EN 45545 Min. 1.000 m or upon request</p>	<p>33.434</p>  <p>Edge trim: EPDM Grip range: 2,0 - 4,0 mm Hardness: SH 65 Insert: 30 mm wire</p>	<p>33.414</p>  <p>Edge trim: PVC, black + bi Grip range: 4,0 - 6,0 mm Hardness: SH 78 / 57 Insert: 31 x 0,5 mm steel</p>	<p>33.419A</p>  <p>Edge trim: PVC, black Grip range: 2,0 - 4,0 mm Hardness: SH 75 Insert: 30 x 0,5 mm steel</p>
<p>33.427X</p>  <p>Edge trim: PVC, black + bi Grip range: 1,5 - 4,5 mm Hardness: SH 75 / 75 Insert: 30 x 0,47 mm steel Yellow lips</p>	<p>33.094X</p>  <p>Edge trim: PVC, black + bi Grip range: 1,0 - 4,0 mm Hardness: SH 75 / 75 Insert: 30 x 0,47 mm steel Yellow lips</p>	<p>33.435X</p>  <p>Edge trim: EPDM Grip range: 5,0 - 8,0 mm Hardness: SH 70 Insert: 31 x 0,5 mm steel</p>	<p>33.1153A</p>  <p>Edge trim: PVC, black Grip range: 6,0 - 8,0 mm Hardness: SH 78 Insert: 32 mm steel</p>
<p>33.1153GA</p>  <p>Edge trim: PVC, grey Grip range: 6,0 - 8,0 mm Hardness: SH 78 Insert: 32 mm steel</p>	<p>33.415</p>  <p>Edge trim: PVC, black Grip range: 5,0 - 7,0 mm Hardness: SH 78 Insert: 29 x 0,48 mm steel</p>	<p>33.426XA</p>  <p>Edge trim: PVC, black Hardness: SH 78 Grip range: 4,5 - 7,0 mm Insert: 32 mm Min. order: 1.000 m</p>	<p>33.426A / 33.426GA</p>  <p>Edge trim: PVC, black, black / grey + bi Hardness: SH 78 / 65 Grip range: 4,5 - 7,0 mm Insert: 32 mm 33.426GA: Grey Min. order: 1.000 m</p>

Kantlister / Edge trims

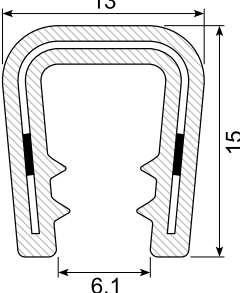
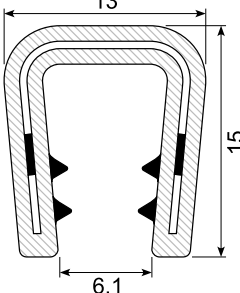
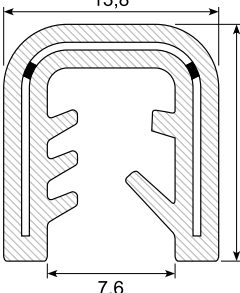
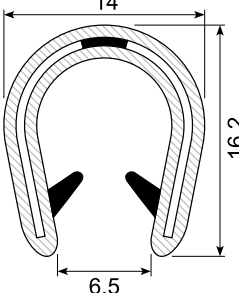
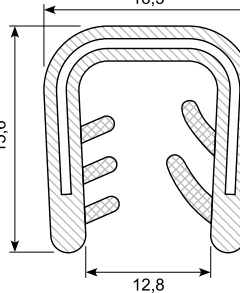
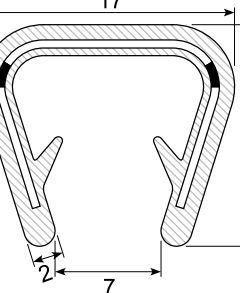
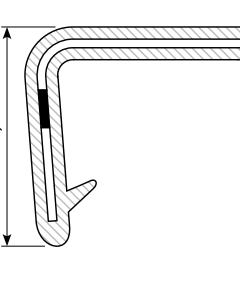
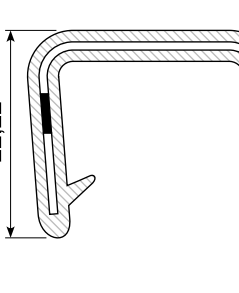
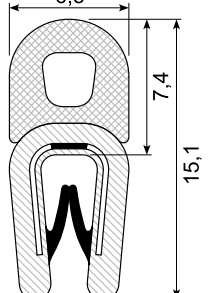
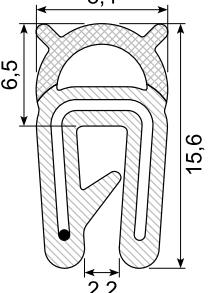
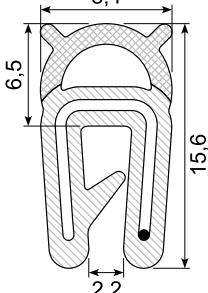
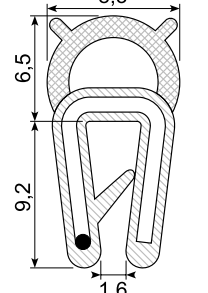
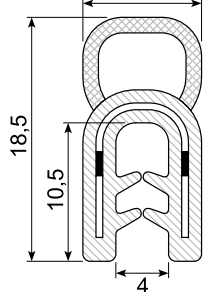
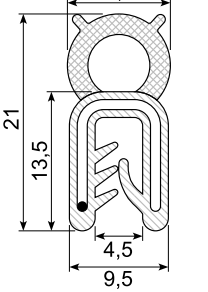
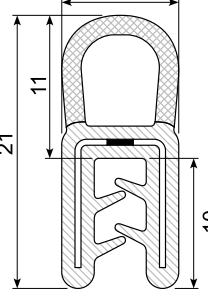
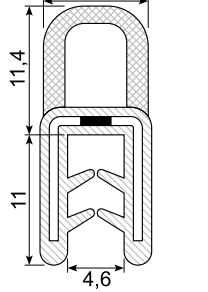
<p>33.426X</p>  <p>Edge trim: PVC, black Grip range: 4,5 - 7,0 mm Hardness: SH 75 Insert: 30 x 0,8 mm steel</p>	<p>33.426</p>  <p>Edge trim: PVC, black + bi Grip range: 4,5 - 7,0 mm Hardness: SH 78 / 65 Insert: 29 x 0,48 mm steel</p>	<p>33.433</p>  <p>Edge trim: EPDM Grip range: 4,0 - 6,0 mm Hardness: SH 70 Insert: 33 x 0,47 mm steel</p>	<p>33.1154</p>  <p>Edge trim: PVC, black Grip range: 6,0 - 8,0 mm Hardness: SH 75 / 75 White lips</p>
<p>33.430</p>  <p>Edge trim: PVC, black + bi Grip range: 10,0-12,0 mm (9-11 mm) Hardness: SH 75 / 57 Insert: 36 x 0,5 steel</p>	<p>33.428 / 33.428G</p>  <p>Edge trim: PVC, black / grey + bi Grip range: 10,0 - 12,0 mm Hardness: SH 78 Insert: 36 x 0,5 mm steel 33.428G: Grey</p>	<p>33.1155</p>  <p>Edge trim: PVC, black Grip range: 15,0 - 16,0 mm Hardness: SH 85 Insert: Steel</p>	<p>33.1156</p>  <p>Edge trim: PVC, black Grip range: 18,0 - 19,0 mm Hardness: SH 85 Insert: Steel</p>
<p>33.354</p>  <p>Edge trim: PVC, black +bi / sponge rubber Grip range: 1,0 - 2,0 mm Hardness: SH 78 / 57 / density 0,55 Insert: 16 x 0,3 mm steel</p>	<p>33.468F</p>  <p>Edge trim: EPDM co-ex Grip range: 1,0 - 2,0 mm Hardness: SH 60 / density 0,8 Insert: 22 x 0,75 mm wire Flame retardant EN 45545</p>	<p>33.468X</p>  <p>Edge trim: EPDM co-ex Grip range: 1,0 - 2,0 mm Hardness: SH 60 / density 0,55 Insert: 22 x 0,75 mm wire</p>	<p>33.468B</p>  <p>Edge trim: EPDM co-ex Grip range: 1,0 - 2,0 mm Hardness: SH 70 / density 0,55 Insert: 22 mm wire</p>
<p>33.358C</p>  <p>Edge trim: EPDM co-ex Grip range: 0,8 - 2,5 mm Hardness: SH 65 Insert: 25 x 0,5 mm steel Min. order: 3.000 m</p>	<p>33.021</p>  <p>Edge trim: EPDM co-ex Grip range: 0,8 - 2,0 mm Hardness: SH 70 / density 0,55 Insert: 25 mm wire</p>	<p>33.358X</p>  <p>Edge trim: EPDM co-ex Grip range: 1,0 - 2,5 mm Hardness: SH 70 / density 0,55 Insert: 26 x 0,5 mm, unbroken</p>	<p>33.358B</p>  <p>Edge trim: EPDM co-ex Grip range: 1,0 - 3,0 mm Hardness: SH 70 / density 0,55 Insert: 27 mm</p>

Kantlister / Edge trims

33.371E EMV - EMC - EMI *

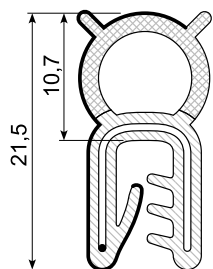

Edge trim: EPDM co-ex
 Grip range: 1,0 - 3,0 mm
 Hardness: SH 70 / density 0,55
 Insert: Wire
Electromagnetic compatibility.
On demand

33.371F *

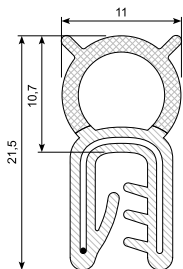

Edge trim: EPDM co-ex
 Grip range: 1,0 - 3,0 mm
 Hardness: SH 65 / density 0,6
 Insert: 26 x 0,75 mm wire
Flame retardant ref. NNF 16101
(Certificate valid only 2016)
Min. order 4.000 m

33.469X

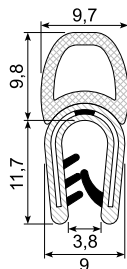

Edge trim: PVC, black +bi /
 sponge rubber
 Grip range: 1,5 - 3,5 mm
 Hardness: SH 75 / 63 /
 density 0,6 - 0,85
 Insert: 26 x 0,47 mm steel

33.371FX

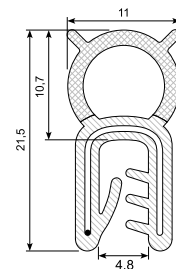

Edge trim: EPDM co-ex
 Grip range: 1,0 - 3,0 mm
 Hardness: SH 60 / density 0,8
 Insert: 26 x 0,75 mm wire
Flame retardant EN 45545

33.371X

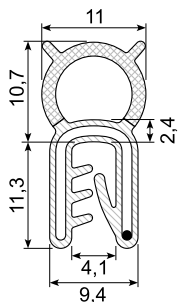

Edge trim: EPDM co-ex
 Grip range: 1,0 - 3,5 mm (1 - 3 mm)
 Hardness: SH 70 / density 0,55
 Insert: 27 mm wire

33.370NBR

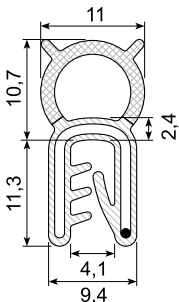

Edge trim: NBR co-ex
 Grip range: 1,0 - 3,0 mm
 Hardness: SH 70 / density 0,55
 Insert: Wire
Oil resistant

33.369

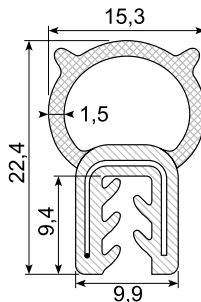

Edge trim: EPDM co-ex
 Grip range: 2,0 - 4,0 mm
 Hardness: SH 65 / density 0,6
 Insert: Wire

33.481

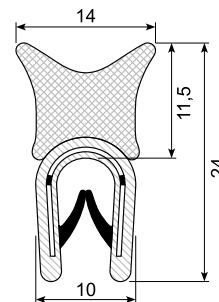

Edge trim: PVC, black +bi /
 spongerubber
 Grip range: 1,0 - 4,0 mm
 Hardness: SH 57 / 78 / density 0,55
 Insert: Steel

33.353NBR *

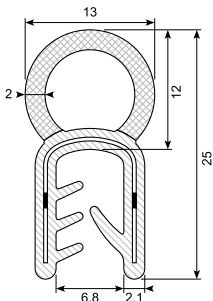

Edge trim: NBR co-ex
 Grip range: 3,0 - 4,0 mm
 Hardness: SH 70 / density 0,55
 Insert: 31 x 0,5 mm
Oil resistant
Min. order: 3.000 m

33.353S *

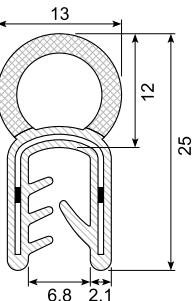

Edge trim: EPDM co-ex
 Grip range: 3,0 - 4,0 mm
 Hardness: SH 65 / density 0,6
 Insert: 31 x 0,5 mm steel
Min. order: 6.000 m

33.353

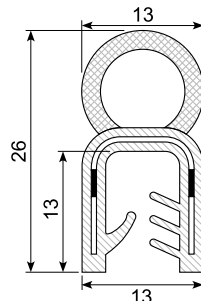

Edge trim: EPDM co-ex
 Grip range: 3,0 - 5,0 mm
 Hardness: SH 65 / density 0,6
 Insert: 32 mm steel

33.352

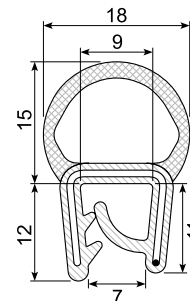

Edge trim: EPDM co-ex
 Grip range: 5,0 - 6,0 mm
 Hardness: SH 78 / density 0,6
 Insert: 31 x 0,5 mm

33.362FX

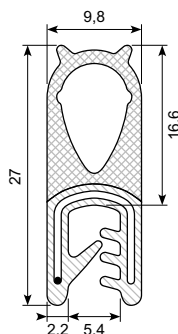

Edge trim: EPDM co-ex
 Grip range: 1,0 - 3,5 mm
 Hardness: SH 60 / density 0,8
 Insert: 26 x 0,75 mm wire
Flame retardant EN 45545

33.357X

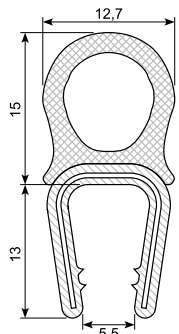

Edge trim: PVC, black /
 sponge rubber
 Grip range: 5,0 - 7,0 mm
 Hardness: SH 78 / density 0,6
 Insert: 31 x 0,5 mm

33.359X

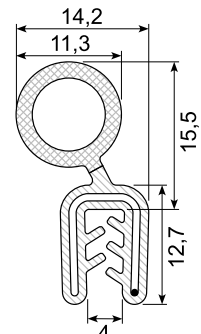

Edge trim: EPDM co-ex
 Grip range: 1,5 - 4,0 mm
 Hardness: SH 70 /
 density 0,6 - 0,85
 Insert: 25 wire

33.353X

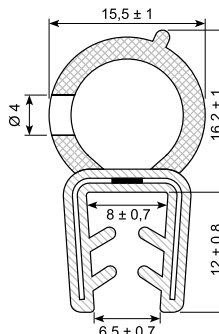

Edge trim: EPDM co-ex
 Grip range: 4,0 - 6,0 mm
 Hardness: SH 65 / density 0,6
 Insert: 33 mm steel

Kantlister / Edge trims

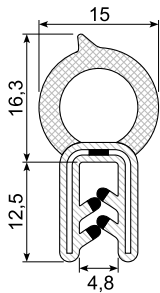
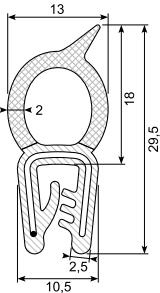
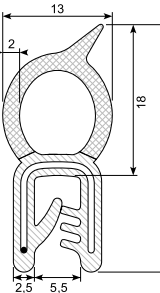
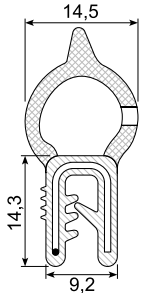
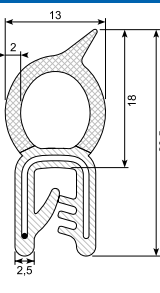
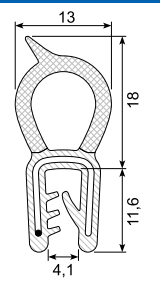
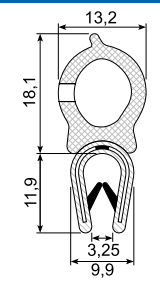
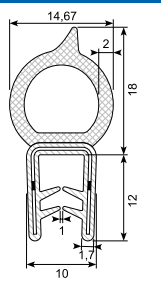
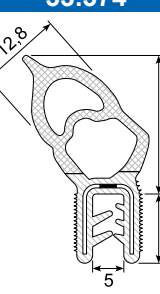
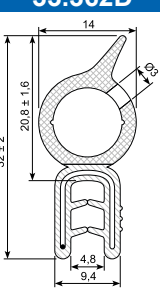
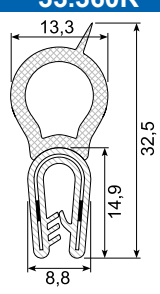
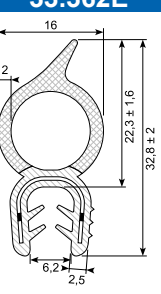
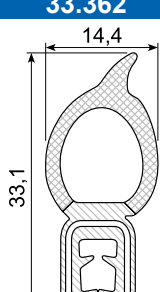
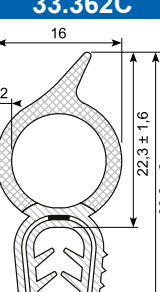
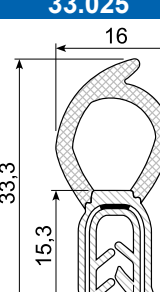
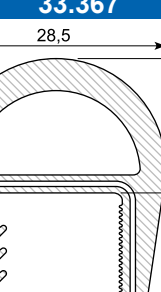
<p>33.376</p>  <p>Edge trim: EPDM co-ex Grip range: 1,0 - 3,5 mm Hardness: SH 70 / density 0,75 Insert: 27 mm steel</p>	<p>33.360</p>  <p>Edge trim: EPDM co-ex Grip range: 1,0 - 2,5 mm Hardness: SH 60 / density 0,6 Insert: 27 x 0,75 mm wire</p>	<p>33.360NBR *</p>  <p>Edge trim: NBR co-ex Grip range: 1,0 - 3,0 mm Hardness: SH 70 / density 0,55 Insert: 27 x 0,75 mm wire Oil resistant Min. order: 4.000 m</p>	<p>33.377</p>  <p>Edge trim: EPDM co-ex Grip range: 1,0 - 3,5 mm Hardness: SH 70 / density 0,75 Insert: 27 mm wire</p>
<p>33.360F *</p>  <p>Edge trim: EPDM co-ex Grip range: 2,0 - 4,0 mm Hardness: SH 65 / density 0,6 Insert: 27 x 0,76 mm wire Flame retardant ref. NNF 16101 (Certificate valid only 2016) Min. order: 3.000 m</p>	<p>33.360X</p>  <p>Edge trim: EPDM co-ex Grip range: 1,0 - 3,0 mm Hardness: SH 70 / density 0,6 Insert: 27 x 0,75 mm wire</p>	<p>33.365X</p>  <p>Edge trim: PVC, black + bi sponge rubber Grip range: 1,0 - 4,0 mm Hardness: SH 75 / 63 / density 0,6 - 0,85 Insert: 26 x 0,47 mm steel</p>	<p>33.362F *</p>  <p>Edge trim: EPDM co-ex Grip range: 2,0 - 4,0 mm Hardness: SH 65 / density 0,6 Insert: 29 x 0,5 mm steel Flame retardant ref. NNF 16101 (Certificate valid only 2016) Min. order: 1.000 m</p>
<p>33.374</p>  <p>Edge trim: EPDM co-ex Grip range: 1,5 - 4,0 mm Hardness: SH 70 / density 0,55 Insert: 27 x 0,47 mm steel</p>	<p>33.362D</p>  <p>Edge trim: EPDM co-ex Grip range: 2,0 - 4,0 mm Hardness: SH 65 / density 0,6 Insert: 27 x 0,75 mm wire</p>	<p>33.360R</p>  <p>Edge trim: PVC, black sponge rubber Grip range: 1,0 - 2,5 mm Hardness: SH 77 / density 0,65 - 0,75 Insert: 26 x 0,5 mm Stainless 304 steel</p>	<p>33.362E *</p>  <p>Edge trim: EPDM co-ex Grip range: 3,0 - 5,0 mm Hardness: SH 65 / density 0,6 Insert: 26 x 0,5 mm steel Min. order: 1.500 m</p>
<p>33.362</p>  <p>Edge trim: EPDM co-ex Grip range: 1,0 - 3,5 mm Hardness: SH 70 / density 0,6 Insert: 26 x 0,76 mm wire</p>	<p>33.362C *</p>  <p>Edge trim: EPDM co-ex Grip range: 1,5 - 3,0 mm Hardness: SH 65 / density 0,6 Insert: 26 x 0,5 mm steel Min. order: 1.000 m</p>	<p>33.025</p>  <p>Edge trim: EPDM co-ex Grip range: 1,5 - 3,5 mm Hardness: SH 70 / density 0,55 Insert: 27 x 0,47 mm steel</p>	<p>33.367 *</p>  <p>Edge trim: EPDM, solid balloon Grip range: 16,0 mm Hardness: SH 60 Insert: 52 x 0,76 mm wire Min. order: 3.030 m</p>

Kantlister / Edge trims

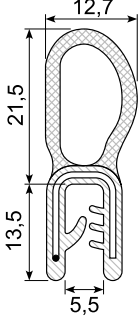
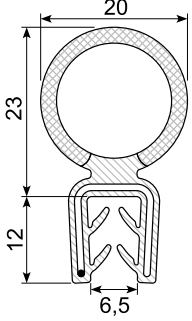
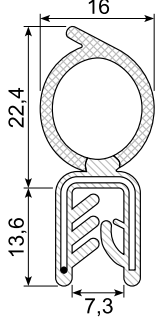
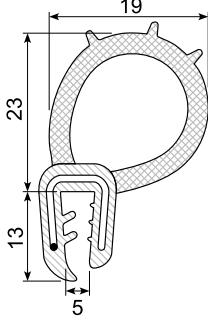
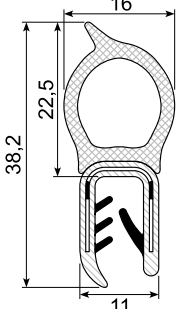
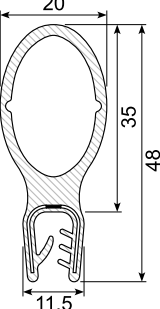
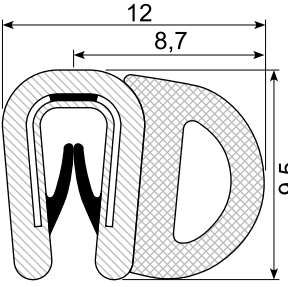
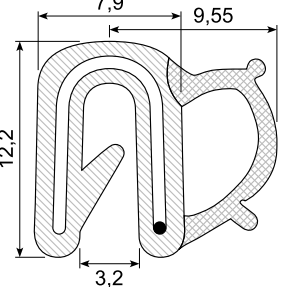
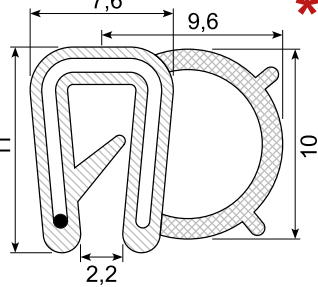
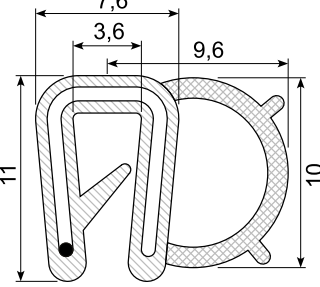
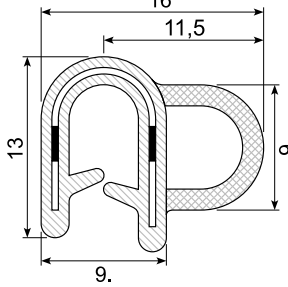
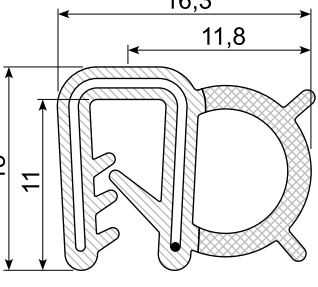
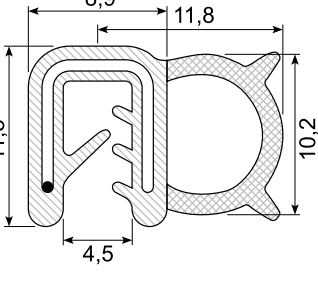
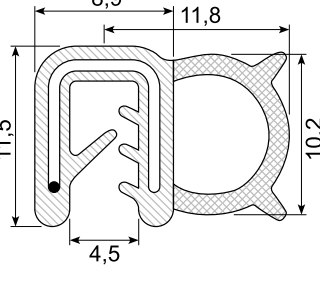
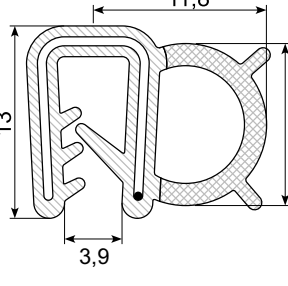
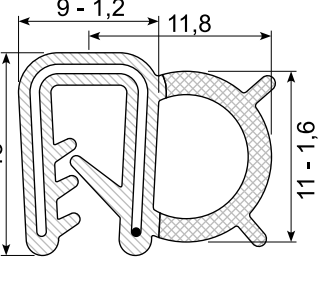
<p>33.380</p>  <p>Edge trim: EPDM co-ex Grip range: 2,0 - 4,0 mm Hardness: SH 70 / density 0,55 Insert: 29 mm wire</p>	<p>33.379</p>  <p>Edge trim: EPDM co-ex Grip range: 2,5 - 5,0 mm Hardness: SH 70 / density 0,55 Insert: 33 mm wire</p>	<p>33.378</p>  <p>Edge trim: EPDM co-ex Grip range: 1,5 - 5,0 mm Hardness: SH 70 / density 0,55 Insert: 33 mm wire</p>	<p>33.375</p>  <p>Edge trim: EPDM co-ex Grip range: 4,0 - 5,0 mm Hardness: SH 70 / density 0,6 - 0,85 Insert: 27 mm wire</p>
<p>33.463</p>  <p>Edge trim: PVC, black + bi / sponge rubber Grip range: 4,0 - 6,0 mm Hardness: SH78/57 density 0,55 Insert: 31 x 0,5 mm steel</p>	<p>33.355B</p>  <p>Edge trim: EPDM, solid balloon Grip range: 3,0 - 5,0 mm Hardness: SH 60 Insert: 31 x 0,5 mm steel, unbroken</p>	<p>33.408X</p>  <p>Edge trim: PVC, black + bi / sponge rubber Grip range: 1,0 - 2,0 mm Hardness: SH 78 / 57 density 0,55 Insert: 16 x 0,3 mm steel</p>	<p>33.407X</p>  <p>Edge trim: EPDM co-ex Grip range: 0,8 - 2,5 mm Hardness: SH 60 / density 0,55 Insert: 22 x 0,75 mm wire</p>
<p>33.403</p>  <p>Edge trim: EPDM co-ex Grip range: 1,0 - 2,0 mm Hardness: SH 70 / density 0,55 Insert: 20 x 0,76 mm wire Min. order: 8.000 m</p>	<p>33.403F</p>  <p>Edge trim: EPDM co-ex Grip range: 1,0 - 2,0 mm Hardness: SH 60 / density 0,8 Insert: 22 x 0,75 mm wire Flame retardant EN 45545</p>	<p>33.9779</p>  <p>Edge trim: EPDM co-ex Grip range: 1,5 - 3,0 mm (1-3 mm) Hardness: SH 70 / density 0,65 Insert: 25 x 0,5 mm steel</p>	<p>33.395A</p>  <p>Edge trim: EPDM co-ex Grip range: 2,0 mm Hardness: SH 60 / density 0,6 Insert: 26 x 0,75 mm wire</p>
<p>33.395X</p>  <p>Edge trim: EPDM co-ex Grip range: 1,0 - 3,0 mm Hardness: SH 70 / density 0,55 Insert: Wire</p>	<p>33.395XX</p>  <p>Edge trim: EPDM co-ex Grip range: 1,0 - 2,0 mm Hardness: SH 70 / density 0,55 Insert: Wire Partivare - udgår Special offer (tolerance mistake)</p>	<p>33.395XA</p>  <p>Edge trim: EPDM co-ex Grip range: 1,0 - 3,0 mm Hardness: SH 70 / density 0,55 Insert: Wire Min. order: 4.500m</p>	<p>33.398</p>  <p>Edge trim: NBR co-ex Grip range: 2,0 mm Hardness: SH 60 / density 0,55 Insert: 27 x 0,76 mm wire Oil resistant</p>

Kantlister / Edge trims

33.395F

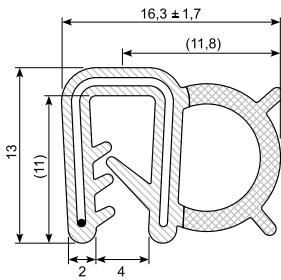

Edge trim: EPDM co-ex
 Grip range: 1,0 - 3,0 mm
 Hardness: SH 60 / density 0,8
 Insert: 26 x 0,75 mm wire
Flame retardant EN 45545

33.381

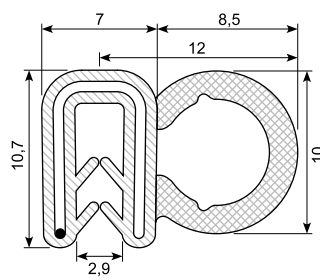

Edge trim: EPDM co-ex
 Grip range: 1,0 - 2,5 mm
 Hardness: SH 70 density 0,55
 Insert: Wire

33.444A

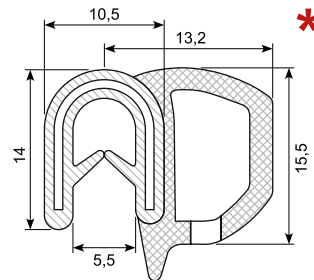

Edge trim: EPDM co-ex
 Grip range: 1,5 - 4,0 mm
 Hardness: SH 70 / density 0,55
 Insert: Wire
Min. order: 1.000 m

33.372X

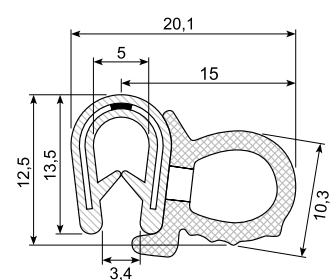

Edge trim: PVC, black + sponge rubber
 Grip range: 1,0 - 3,5 mm
 Hardness: SH 75 / 75 / density 0,6 - 0,85
 Insert: 22 x 0,47 mm steel

33.506

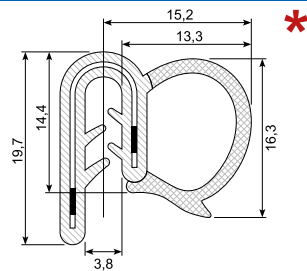

Edge trim: EPDM co-ex
 Grip range: 1,0 - 2,5 mm
 Hardness: SH 70 / density 0,6
 Insert: 30 x 0,47 mm steel
Min. order: 4.000 m

33.480

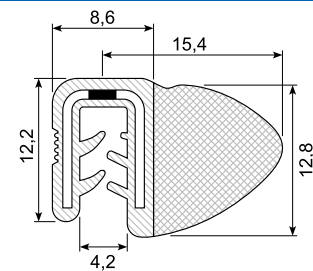

Edge trim: EPDM co-ex
 Grip range: 1,0 - 3,5 mm
 Hardness: SH 70 / density 0,55
 Insert: Steel

33.396

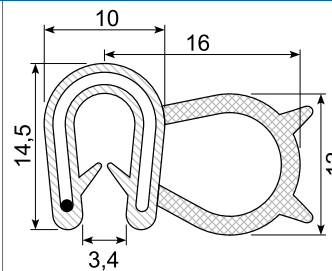

Edge trim: EPDM co-ex
 Grip range: 1,0 - 3 mm
 Hardness: SH 70 / density 0,6 - 0,85
 Insert: 27 mm wire

33.444X

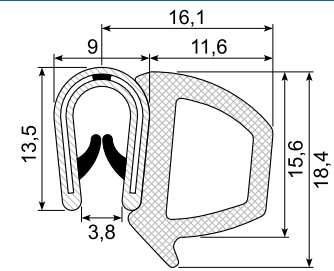

Edge trim: PVC, black + bi sponge rubber
 Grip range: 1,0 - 3,5 mm
 Hardness: SH75 / 75 / density 0,6-0,86
 Insert: 26 x 0,47 mm steel
Red lips

33.319

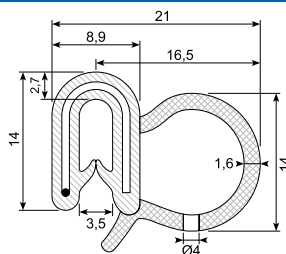

Edge trim: EPDM co-ex
 Grip range: 1,0 - 3,0 mm
 Hardness: SH 70 / density 0,6 0,85
 Insert: Wire

33.319F

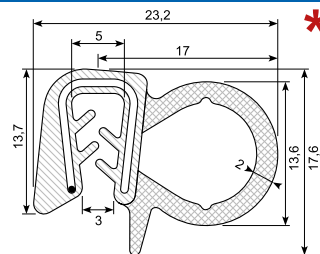

Edge trim: EPDM co-ex
 Grip range: 1,0 - 2,0 mm
 Hardness: SH 70 / density 0,6
 Insert: 26 x 0,75 mm wire
Flame retardant ref. NNF 16101 (Certificate valid only 2016)
Min. order: 3.000 m

33.323

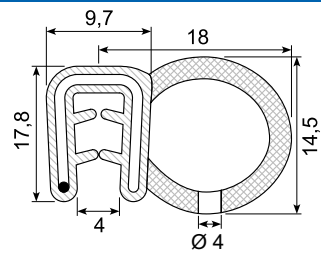

Edge trim: EPDM co-ex
 Grip range: 1,5 - 3,5 mm
 Hardness: SH 70 / density 0,6 - 0,85
 Insert: 27 mm

33.324CR

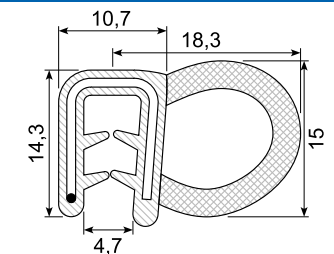

Edge trim: CR co-ex
 Grip range: 1,0 - 3,5 mm
 Hardness: SH70 / density 0,6-0,85
 Insert: 29 mm wire
Conditional oil resistant

33.338F

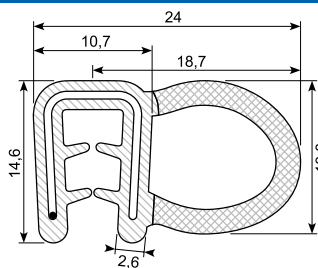

Edge trim: EPDM co-ex
 Grip range: 1,5 - 3,0 mm
 Hardness: SH 65 / density 0,60
 Insert: 30 x 0,75 mm wire
Flame retardant EN45545

33.450NBR

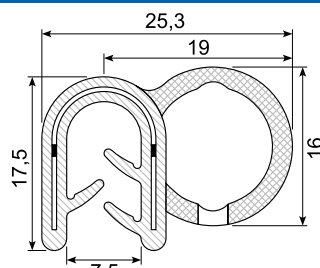

Edge trim: NBR co-ex
 Grip range: 4,0 - 6,0 mm (3 - 6 mm)
 Hardness: SH 70 / density 0,55
 Insert: 34 x 0,5 mm steel
Oil resistant

33.457

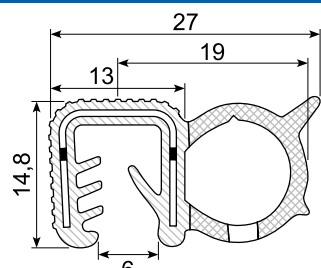

Edge trim: EPDM co-ex
 Grip range: 5,0 - 6,0 mm
 Hardness: SH 60 / density 0,6
 Insert: 32 x 0,6 mm steel, unbroken

33.457ST

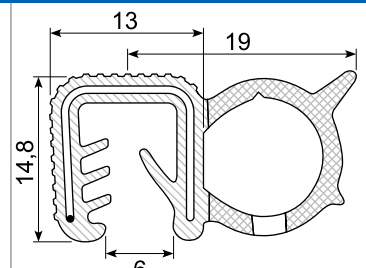

Edge trim: EPDM co-ex
 Grip range: 5,0 - 6,0 mm
 Hardness: SH 60 / density 0,55
 Insert: 31 x 0,76 mm wire

Kantlister / Edge trims

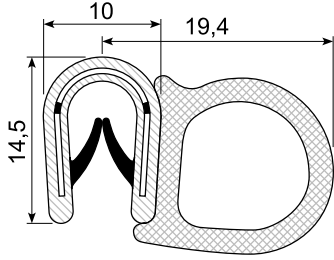
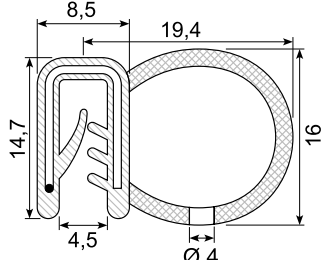
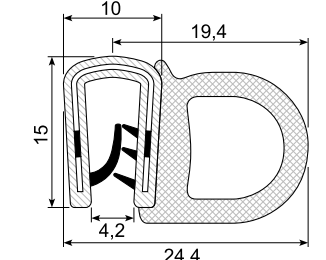
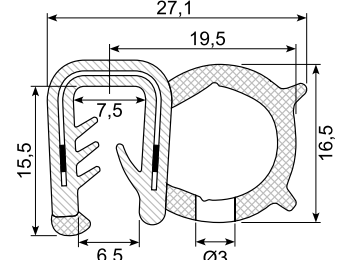
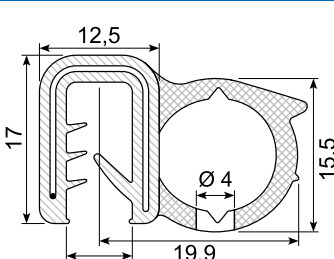
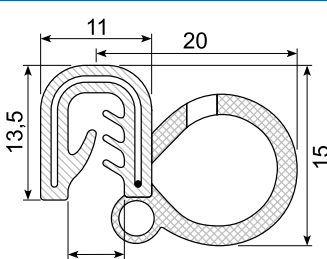
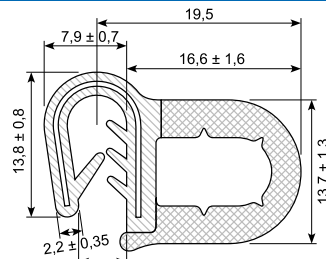
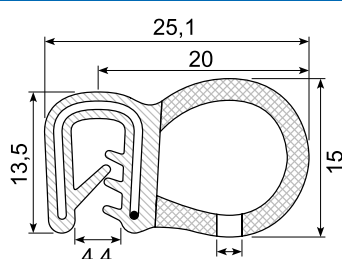
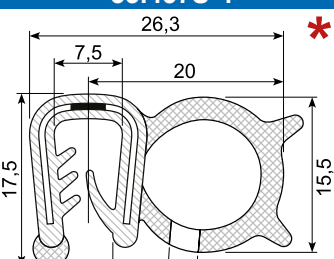
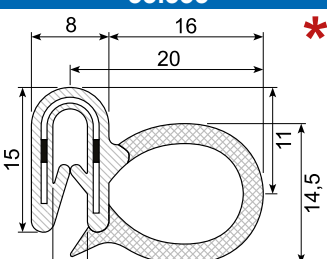
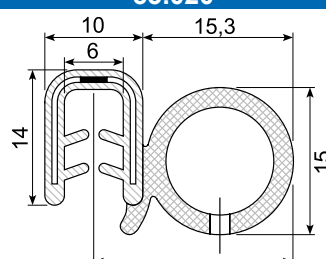
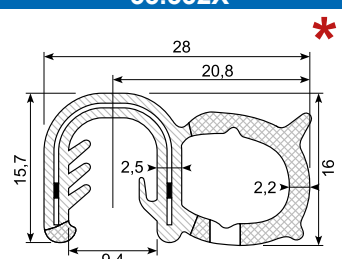
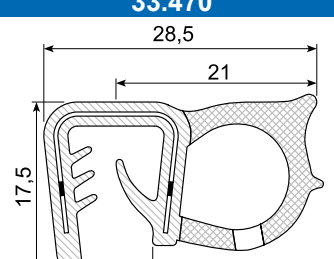
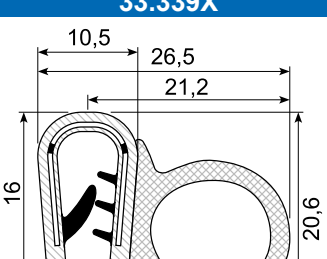
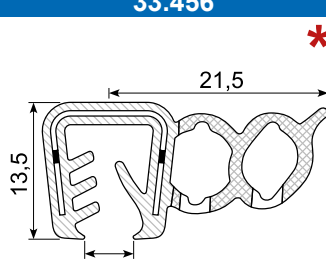
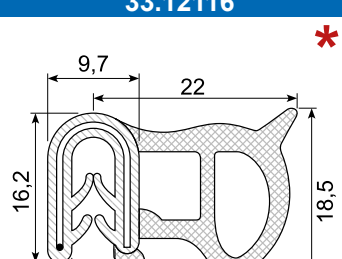
<p>33.449</p>  <p>Edge trim: PVC, black +bi / sponge rubber Grip range: 1,0 - 4,0 mm Hardness: SH78/57 / density 0,55 Insert: 26 x 0,5 mm steel</p>	<p>33.321</p>  <p>Edge trim: EPDM co-ex Grip range: 1,0 - 3,5 mm Hardness: SH 70 / density 0,6 - 0,85 Insert: 27 mm wire</p>	<p>33.452R</p>  <p>Edge trim: PVC, black +bi / sponge rubber Grip range: 2,0 - 4,0 mm Hardness: SH 78 / 65 density 0,65 - 0,75 Insert: 29 x 0,48 mm Stainless Steel</p>	<p>33.457S-6</p>  <p>Edge trim: EPDM co-ex Grip range: 3,0 - 6,0 mm Hardness: SH 70 / density 0,6 Insert: 32 x 0,47 steel</p>
<p>33.024</p>  <p>Edge trim: EPDM co-ex Grip range: 2,0 - 4,0 mm (2 - 5 mm) Hardness: SH 70 / density 0,55 Insert: 33 mm wire</p>	<p>33.454X</p>  <p>Edge trim: EPDM co-ex Grip range: 2,0 mm Hardness: SH 70 / density 0,55 Insert: 27 x 0,76 mm wire</p>	<p>33.451E</p>  <p>Edge trim: EPDM co-ex Grip range: 2,0 - 5,0 mm Hardness: SH 70 / density 0,6 Insert: 30 mm steel</p>	<p>33.335</p>  <p>Edge trim: EPDM co-ex Grip range: 1,5 - 3,5 mm Hardness: SH70 / density 0,55-0,85 Insert: 27 mm wire</p>
<p>33.457S-4</p>  <p>Edge trim: EPDM co-ex Grip range: 2,0 - 4,0 mm Hardness: SH 70 / density 0,6 Insert: Steel Min. order: 3.000 m</p>	<p>33.333</p>  <p>Edge trim: EPDM co-ex Grip range: 1,0 - 3,0 mm Hardness: SH 65 / density 0,6 Insert: 29 x 0,5 mm steel Min. order: 4.000 m</p>	<p>33.020</p>  <p>Edge trim: EPDM co-ex Grip range: 1,5 - 3,0 mm Hardness: SH 70 / density 0,55 Insert: 27 x 0,47 mm steel</p>	<p>33.332X</p>  <p>Edge trim: EPDM co-ex Grip range: 5,0 - 6,0 mm Hardness: SH 70 / density 0,6 Insert: 33 x 0,5 steel Min. order: 5.000 m</p>
<p>33.470</p>  <p>Edge trim: EPDM co-ex Grip range: 5,0 - 8,0 mm Hardness: SH 70 / density 0,6 Insert: 36 x 0,5 mm steel</p>	<p>33.339X</p>  <p>Edge trim: PVC, black+bi / sponge rubber Grip range: 2,5 - 4,0 mm Hardness: SH 78 / 65 Insert: Steel</p>	<p>33.456</p>  <p>Edge trim: EPDM co-ex Grip range: 5,0 - 6,0 mm Hardness: SH 70 / density 0,6 Insert: 30 x 0,6 mm steel Min. order: 4.000 m</p>	<p>33.12116</p>  <p>Edge trim: EPDM co-ex Grip range: 1,0 - 4,0 mm Hardness: SH 70 / density 0,6 - 0,85 Insert: 29 mm wire Min. order: 3.000 m</p>

Kantlister / Edge trims

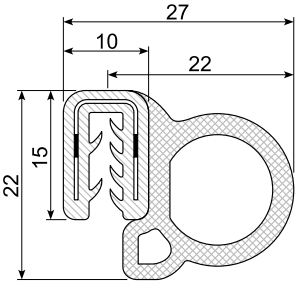
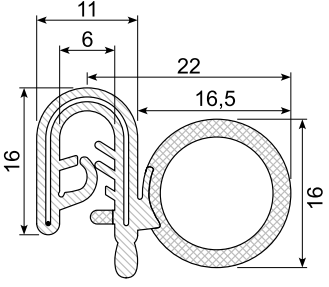
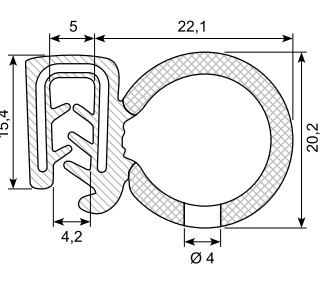
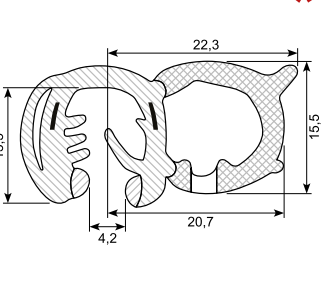
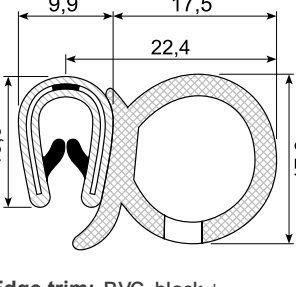
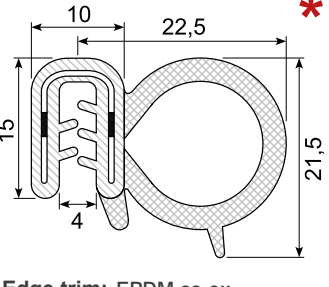
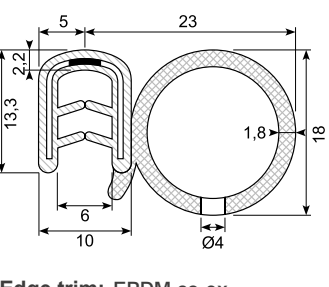
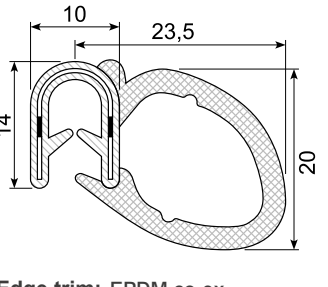
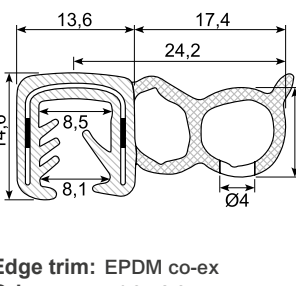
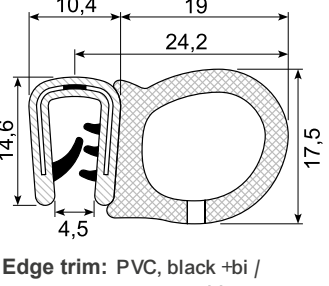
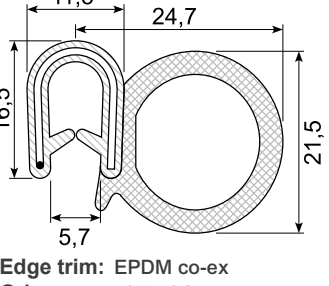
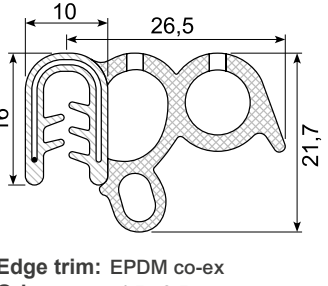
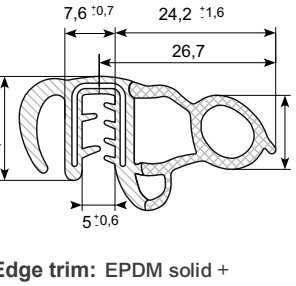
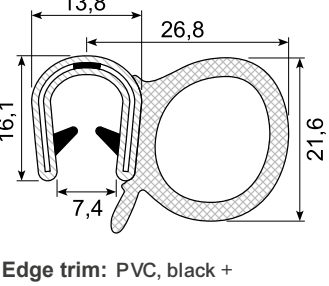
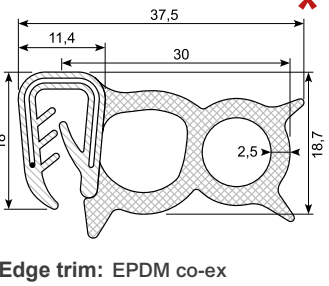
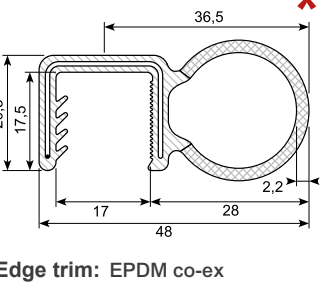
<p>33.328 *</p>  <p>Edge trim: EPDM co-ex Grip range: 1,5 - 2,5 mm Hardness: SH 65 / density 0,6 Insert: 29 x 0,5 mm steel Min. order: 4.000 m</p>	<p>33.022</p>  <p>Edge trim: EPDM co-ex Grip range: 1,5-3,0 mm (1,5-4 mm) Hardness: SH 70 / density 0,6 Insert: 33 mm wire</p>	<p>33.340</p>  <p>Edge trim: EPDM co-ex Grip range: 2,0 - 4,0 mm Hardness: SH 70 Insert: 29 x 0,74 mm steel</p>	<p>33.332B *</p>  <p>Edge trim: EPDM co-ex Grip range: 3,0 - 6,0 mm Hardness: SH 70 / density 0,55 Insert: 32 mm Steel Min. order: 1.000 m</p>
<p>33.453X</p>  <p>Edge trim: PVC, black + sponge rubber Grip range: 1,0 - 3,5 mm Hardness: SH75 / 75 / density 0,6-0,85 Insert: 26 x 0,47 mm steel</p>	<p>33.320 *</p>  <p>Edge trim: EPDM co-ex Grip range: 1,0 - 2,5 mm Hardness: SH 65 / density 0,6 Insert: 29 x 0,5 mm steel Min. order: 4.000 m</p>	<p>33.019</p>  <p>Edge trim: EPDM co-ex Grip range: 1,0 - 4,0 mm Hardness: SH 70 / density 0,6 - 0,85 Insert: Steel</p>	<p>33.447</p>  <p>Edge trim: EPDM co-ex Grip range: 2,5 - 5,0 mm Hardness: SH 70 / density 0,6 Insert: Steel</p>
<p>33.455</p>  <p>Edge trim: EPDM co-ex Grip range: 4,0 - 6,0 mm Hardness: SH 70 / density 0,6 Insert: Steel, unbroken</p>	<p>33.452X</p>  <p>Edge trim: PVC, black +bi / sponge rubber Grip range: 2,0 - 4,0 mm Hardness: SH 78 / 65 density 0,65 - 0,75 Insert: 29 x 0,48 mm</p>	<p>33.326</p>  <p>Edge trim: EPDM co-ex Grip range: 1,5 - 4,0 mm Hardness: SH70/ density 0,55 - 0,85 Insert: 33 mm wire</p>	<p>33.464</p>  <p>Edge trim: EPDM co-ex Grip range: 1,5 - 3,5 mm Hardness: SH 70 / density 0,6 Insert: 31 x 0,75 mm wire</p>
<p>33.466</p>  <p>Edge trim: EPDM solid + EPDM sponge Hardness: SH 70 +- 5 Density: 1,3 +- 0,03</p>	<p>33.331</p>  <p>Edge trim: PVC, black + sponge rubber Grip range: 6,0 - 8,0 mm Hardness: SH75/75 / density 0,6-0,85 Insert: 30 x 0,47 mm steel White lips</p>	<p>33.456F *</p>  <p>Edge trim: EPDM co-ex Grip range: 2,0 - 4,0 mm Hardness: SH 65 / density 0,6 Insert: 31 x 0,75 mm wire Flame retardant ref. NNF 16101 (Certificate valid only 2016) Min. order: 3.000 m</p>	<p>33.478 *</p>  <p>Edge trim: EPDM co-ex Grip range: 16,0 mm Hardness: SH 60 / density 0,6 Insert: 52 x 0,76 mm wire Min. order: 3.000 m</p>

Kantlister / Edge trims

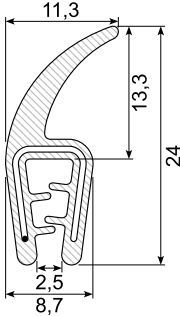
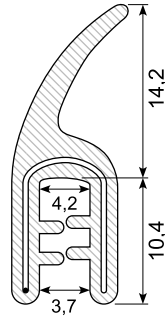
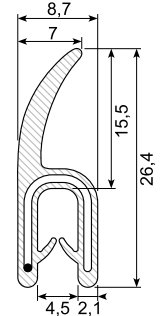
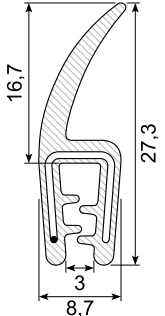
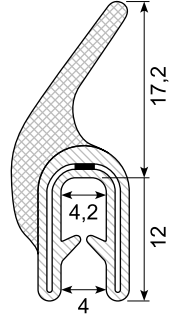
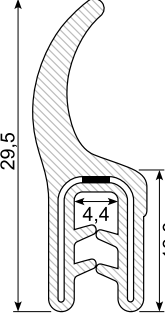
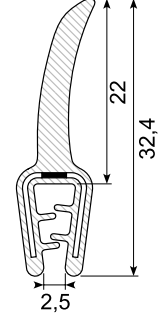
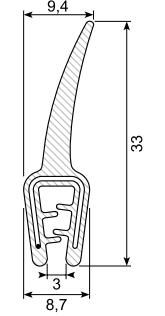
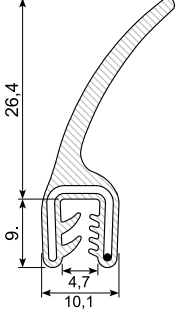
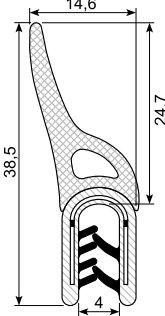
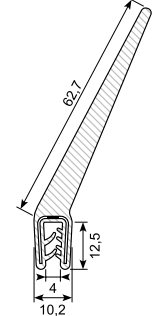
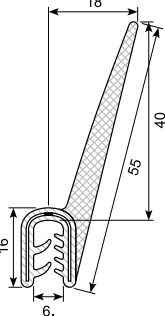
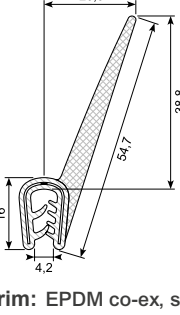
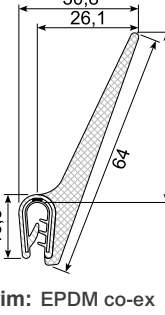
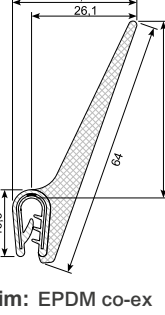
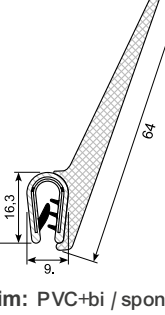
<p>33.458X</p>  <p>Edge trim: EPDM, solid lip Grip range: 1,0 - 2,5 mm Hardness: SH 60 Insert: 26 x 0,76 mm wire</p>	<p>33.458A</p>  <p>Edge trim: EPDM co-ex Grip range: 1,0 - 3,0 mm Hardness: SH 70 Insert: Wire</p>	<p>33.465C</p>  <p>Edge trim: EPDM solid lip Grip range: 2,0 - 4,0 mm Hardness: SH 70 Insert: 27 x 0,76 wire</p>	<p>33.465X</p>  <p>Edge trim: EPDM, solid lip Grip range: 1,0 - 3,0 mm Hardness: SH 60 Insert: 26 x 0,76 mm wire</p>
<p>33.479</p>  <p>Edge trim: EPDM co-ex Grip range: 2,0 - 4,0 mm Hardness: SH 70 / density 0,6 Insert: Steel</p>	<p>33.465B *</p>  <p>Edge trim: EPDM, solid lip Grip range: 1,0 - 3,0 mm Hardness: SH 70 Insert: 27 x 0,5 mm steel unbroken Min. order: 3.000 m</p>	<p>33.459P</p>  <p>Edge trim: PVC, solid lip Grip range: 1,0 - 2,5 mm Hardness: SH 57 Insert: 24 x 0,5 mm steel, unbroken</p>	<p>33.459X</p>  <p>Edge trim: EPDM solid lip Grip range: 1,0 - 2,5 mm Hardness: SH 60 Insert: 26 x 0,76 mm wire</p>
<p>33.459B</p>  <p>Edge trim: EPDM solid lip Grip range: 1,5 - 3,0 mm Hardness: SH 70 Insert: Wire</p>	<p>33.475</p>  <p>Edge trim: PVC + bi / sponge rubber Grip range: 2,0 - 4,0 mm Hardness: SH 78 / 57 / density 0,55 Insert: Steel</p>	<p>33.382</p>  <p>Edge trim: EPDM co-ex, solid lip Grip range: 1,0 - 3,5 mm Hardness: SH 70 Insert: Steel</p>	<p>33.482</p>  <p>Edge trim: EPDM co-ex, solid lip Grip range: 2,0 - 4,5 mm Hardness: SH 70 Insert: 30 x 0,47 mm steel</p>
<p>33.483</p>  <p>Edge trim: EPDM co-ex, solid lip Grip range: 1,0 - 2,5 mm Hardness: SH 70 Insert: 30 x 0,47 mm steel</p>	<p>33.460-2C</p>  <p>Edge trim: EPDM co-ex Grip range: 1,0 - 2,5 mm Hardness: SH 70 / density 0,6 Insert: 31 x 0,5 mm steel, unbroken</p>	<p>33.460-2F *</p>  <p>Edge trim: EPDM co-ex Grip range: 1,0 - 2,5 mm Hardness: SH 65 / density 0,6 Insert: 31 x 0,5 mm steel Flame retardant ref. NNF 16101 (Certificate valid only 2016) Min. order: 3.000 m</p>	<p>33.460-2X</p>  <p>Edge trim: PVC+bi / sponge rubber Grip range: 1,0 - 2,5 mm Hardness: SH 78/57 / density 0,6 Insert: 31 x 0,5 mm steel</p>

Kantlister / Edge trims

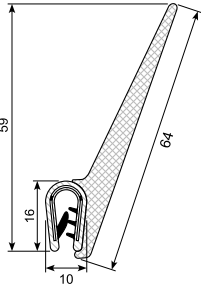
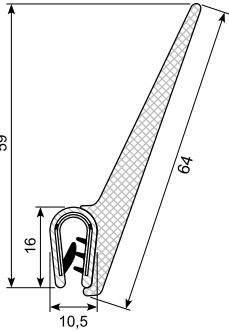
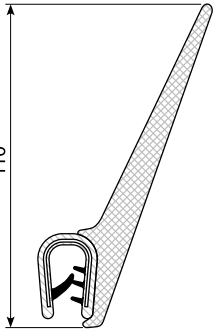
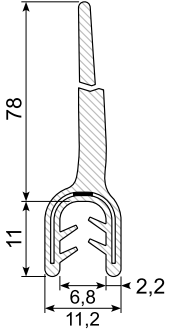
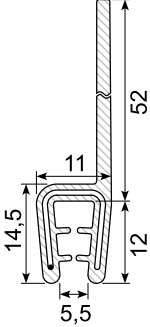
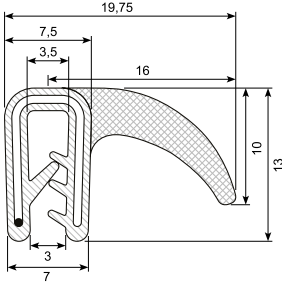
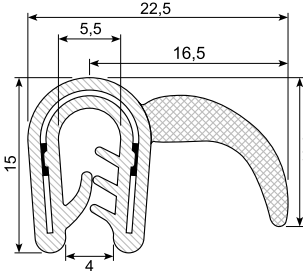
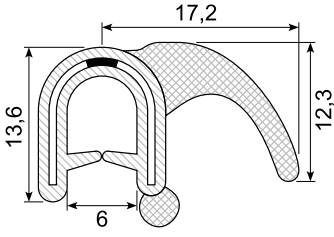
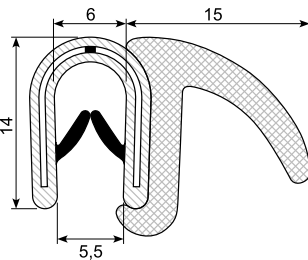
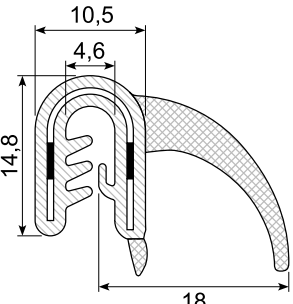
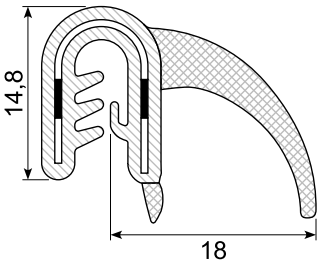
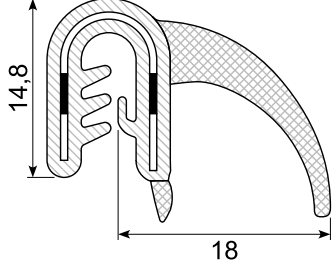
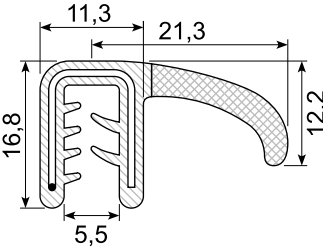
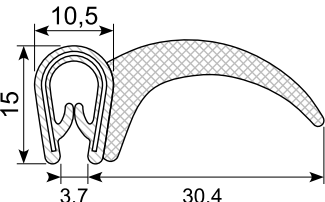
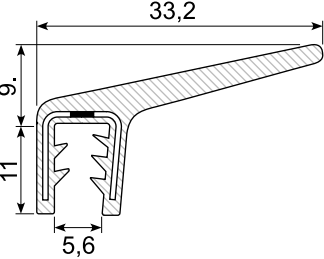
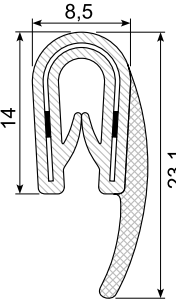
<p>33.460-4X</p>  <p>Edge trim: PVC+bi / sponge rubber Grip range: 2,0 - 4,0 mm Hardness: SH 78/57 / density 0,6 Insert: 31 x 0,5 mm steel</p>	<p>33.460-6X</p>  <p>Edge trim: PVC+bi / sponge rubber Grip range: 4,0 - 6,0 mm 25 m Hardness: SH 78/57 / density 0,6 Insert: 31 x 0,5 mm steel</p>	<p>33.460-6XL</p>  <p>Edge trim: PVC+bi/sponge rubber Grip range: 3,0 - 6,0 mm Hardness: SH 75/57 density 0,6 Insert: Steel</p>	<p>33.472</p>  <p>Edge trim: EPDM, solid lip Grip range: 2,0 - 4,0 mm Hardness: SH 70 Insert: 29 x 0,5 mm, unbroken</p>
<p>33.471</p>  <p>Edge trim: EPDM, solid lip Grip range: 3,0 - 4,0 mm Hardness: SH 60 solid lip Insert: 29 x 0,76 mm wire</p>	<p>33.443X</p>  <p>Edge trim: EPDM co-ex Grip range: 1,0 - 2,0 mm Hardness: SH 60 / density 0,6 Insert: Wire</p>	<p>33.383</p>  <p>Edge trim: EPDM co-ex Grip range: 2,0 - 4,0 mm Hardness: SH 70 / density 0,6 Insert: 30 x 0,5 steel</p>	<p>33.474</p>  <p>Edge trim: EPDM co-ex Grip range: 2,0 - 5,0 mm Hardness: SH 70 / density 0,6 - 0,85 Insert: 27 mm steel</p>
<p>33.439A</p>  <p>Edge trim: PVC+bi / sponge rubber Grip range: 1,0 - 4,0 mm Hardness: SH 78/57 / density 0,6 Insert: 26 x 0,5 mm steel Yellow lips</p>	<p>33.026</p>  <p>Edge trim: EPDM co-ex Grip range: 1,5 - 2,0 mm (1-3,5 mm) Hardness: SH 70 / density 0,55 Insert: 26 x 0,76 mm wire</p>	<p>33.026XA</p>  <p>Edge trim: EPDM co-ex Grip range: 2,0 - 3,0 mm Hardness: SH 70 / density 0,55 Insert: 26 x 0,76 mm wire</p>	<p>33.026X</p>  <p>Edge trim: EPDM co-ex Grip range: 3,0 - 4,0 mm Hardness: SH 70 / density 0,55 Insert: 26 x 0,76 mm wire</p>
<p>33.436</p>  <p>Edge trim: EPDM co-ex Grip range: 2,0 - 4,0 mm Hardness: SH 70 / density 0,6 Insert: 33 mm wire</p>	<p>33.442</p>  <p>Edge trim: EPDM co-ex Grip range: 1,0 - 3,0 mm Hardness: SH 70 / density 0,65 Insert: 29 mm steel</p>	<p>33.473</p>  <p>Edge trim: EPDM co-ex Grip range: 2,0 - 5,0 mm Hardness: SH 70 Insert: 27 x 0,47 mm steel</p>	<p>33.462</p>  <p>Edge trim: PVC / sponge rubber Grip range: 1,0 - 2,5 mm Hardness: SH 78 / density 0,65 - 0,75 Insert: 25 x 0,48 mm steel</p>

Kantlister / Edge trims

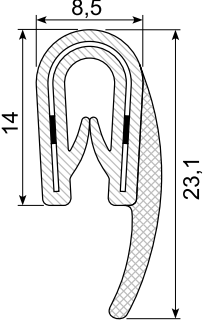
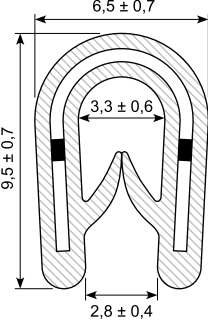
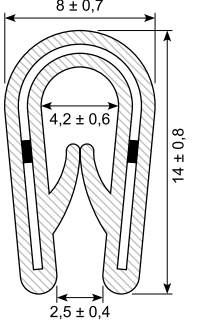
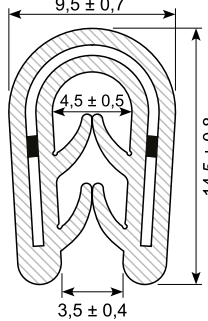
33.462R	33.409ALU *	33.310ALU *	33.432ALU *
			
<p>Edge trim: PVC / sponge rubber Grip range: 1,0 - 2,5 mm Hardness: SH 78/ density 0,65 - 0,75 Insert: 25 x 0,48 mm Stainless Steel</p>	<p>Edge trim: PVC, black Grip range: 0,8 - 2,0 mm Hardness: SH 75 Insert: 17,5 mm aluminium Min. order: 10.000 m</p>	<p>Edge trim: PVC, black Grip range: 1,0 - 2,5 mm Hardness: SH 75 Insert: 26 mm aluminium Min. order: 10.000 m</p>	<p>Edge trim: EPDM Grip range: 2,0 - 4,0 mm Hardness: SH 65 Insert: 26 mm aluminium Min. order: 10.000 m</p>

33.000

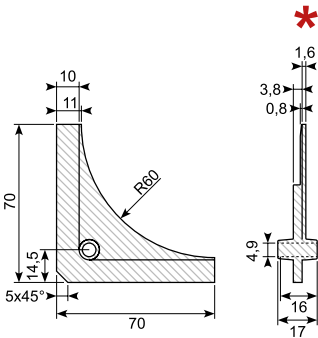

Nylon hjørnestykke
 PA6 + 30% GF
 Sikrer korrekt hjørneradius
Min. order: 100

Konfigurer din egen kantliste eller vælg fra de 2.000 vi har på lager.
 Configure your own edge trim or choose from the 2.000 we have in stock.

